

56.52
CBH-R

Flange concrete screw - 500h ceramic coating

SEND THE INQUIRY

+48 58 55 40 410

Standards:

ETA-14/0374

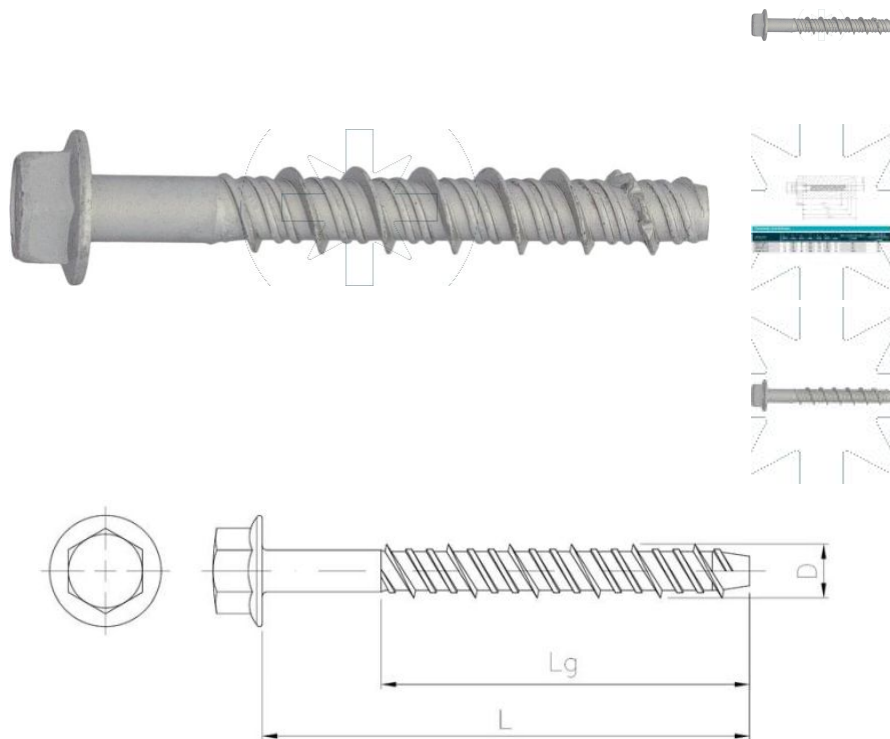

Dimensions

Material index	D [mm]	L [mm]	Lg [mm]	tfix [mm]	Type of coating
5652165115H05S	16.5	115	80	5	Silver Ruspert
5652125110H05S	12.5	100	70	30	Silver Ruspert
5652125085H05S	12.5	85	70	15	Silver Ruspert
5652105090H05S	10.5	90	60	30	Silver Ruspert
5652105110H05S	10.5	110	60	50	Silver Ruspert
5652075060H05S	7.5	60	50	5	Silver Ruspert
5652075080H05S	7.5	80	50	25	Silver Ruspert