

SEND THE INQUIRY

+48 58 55 40 410

Standards:

DIN 6923
ISO 1661
PN-M 82168

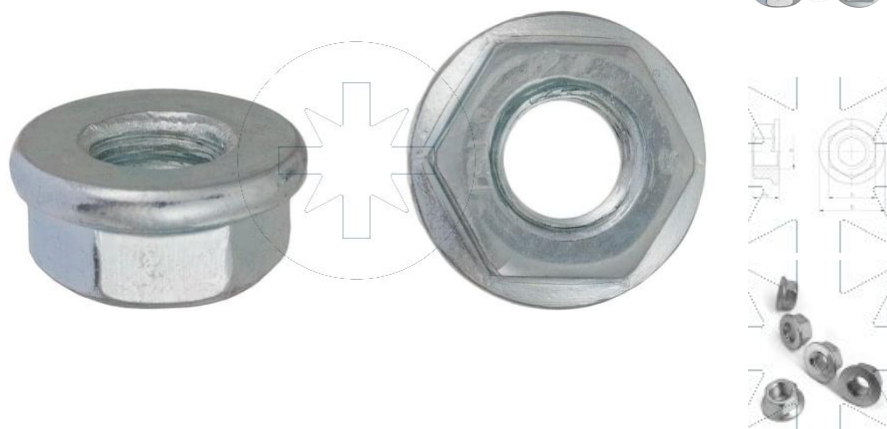

Coating (standard):

B
WHITE
ZINC
COATING

Coating (special order):

A
YELLOW
ZINC
COATING

C
BLACK
ZINC
COATING

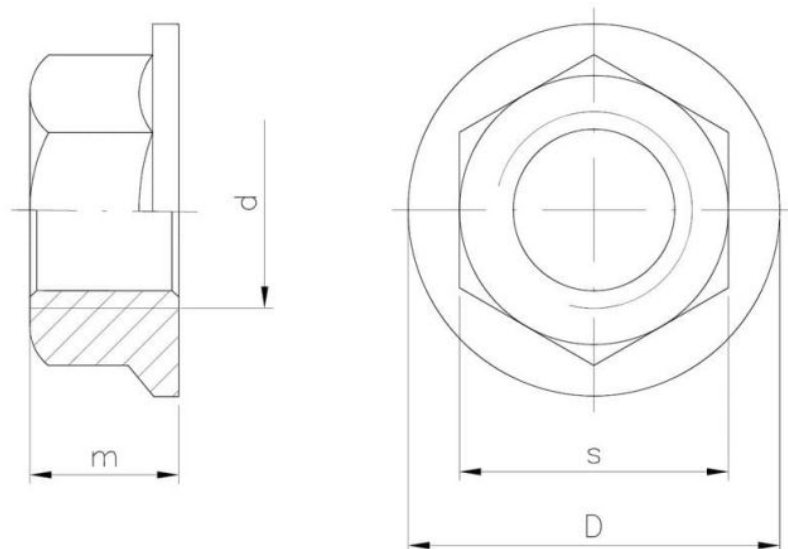

Dimensions

Material index	d	D [mm]	m [mm]	s [mm]	Type of coating
1505080BD6923T	M8	17.9	8.0	13.0	B (White zinc coating)
1505060BD6923T	M6	14.2	6.0	10.0	B (White zinc coating)
1505050BD6923T	M5	11.8	5.0	8.0	B (White zinc coating)
1505160BD6923T	M16	34.5	16.0	24.0	B (White zinc coating)
1505120BD6923T	M12	26.0	12.0	18.0	B (White zinc coating)
1505100BD6923T	M10	21.8	10.0	17.0	B (White zinc coating)