

15.20 Square weld nut
NZ4

SEND THE INQUIRY

+48 58 55 40 410

Standards:

DIN 928

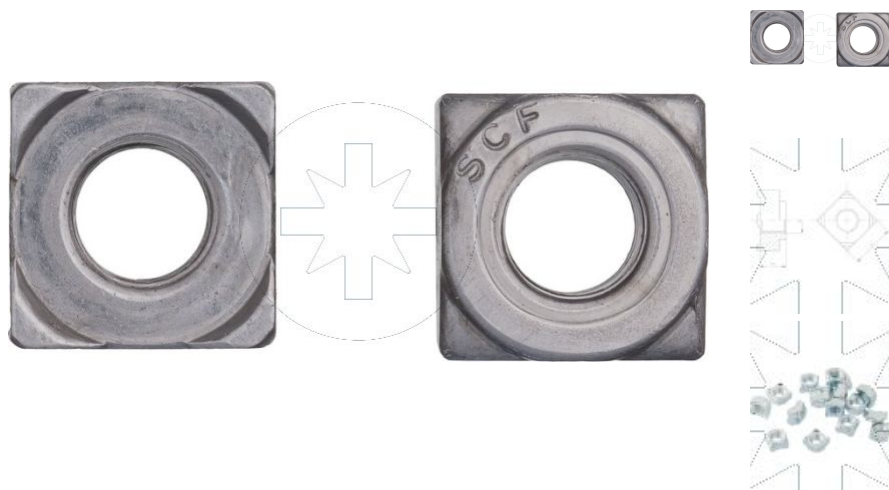

Coating (standard):

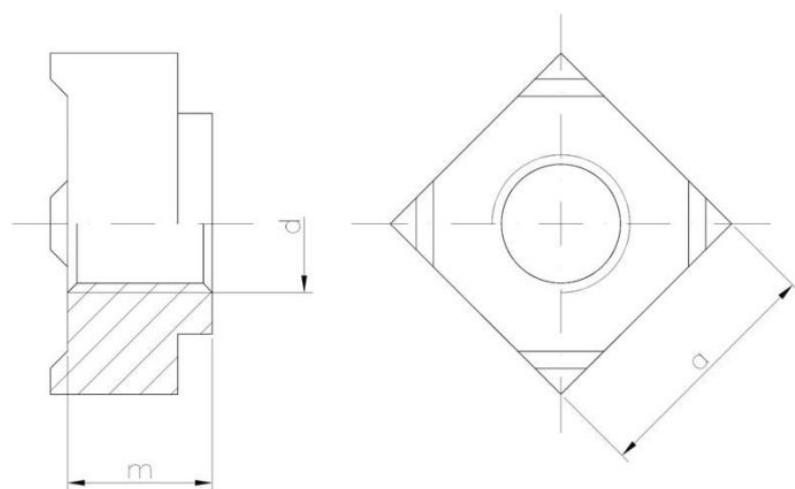

Dimensions

Material index	d	a [mm]	m [mm]	Type of coating
1520100SD928T	M10	17.0	8.0	S (raw product)
1520080SD928T	M8	14.0	6.5	S (raw product)
1520060SD928T	M6	10.0	5.0	S (raw product)
1520040SD928T	M4	7.0	3.5	S (raw product)